

© 2017 Speech Processing Solutions GmbH. All rights reserved.

Specifications are subject to change without notice. Philips and the Philips shield emblem are registered trademarks of Koninklijke Philips N.V. and are used under license.

Document version 4.0, 2017/10/24, 5103 109 9775.4

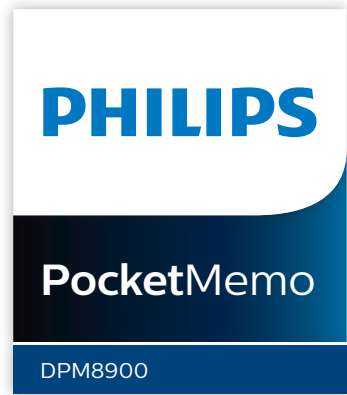

Quick start guide

For product information and support, visit www.philips.com/dictation

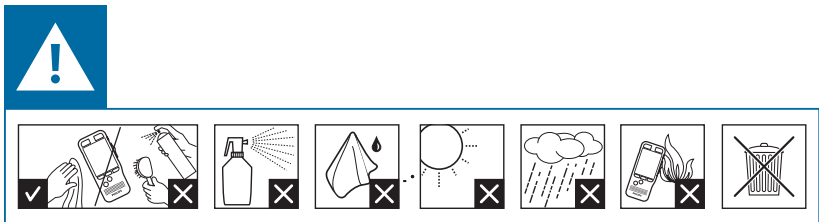
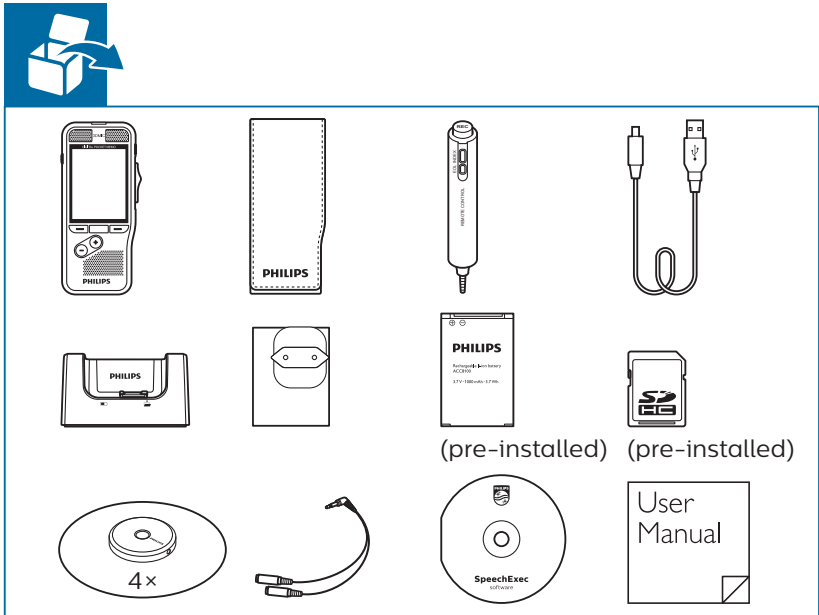

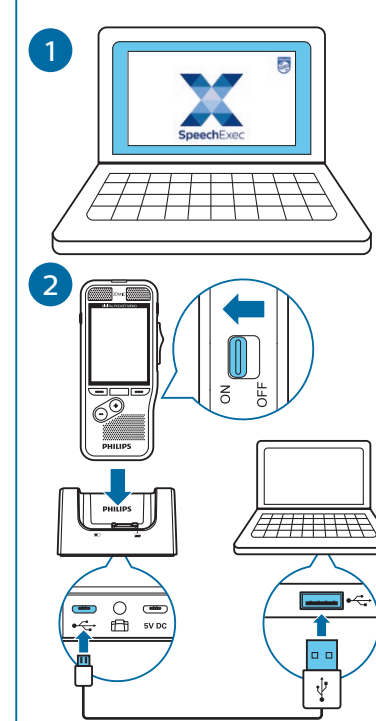
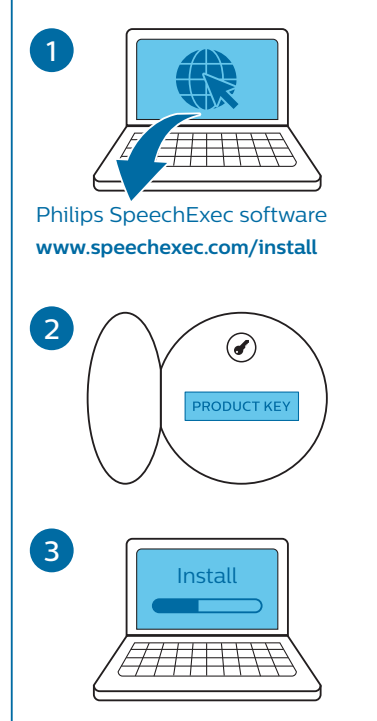
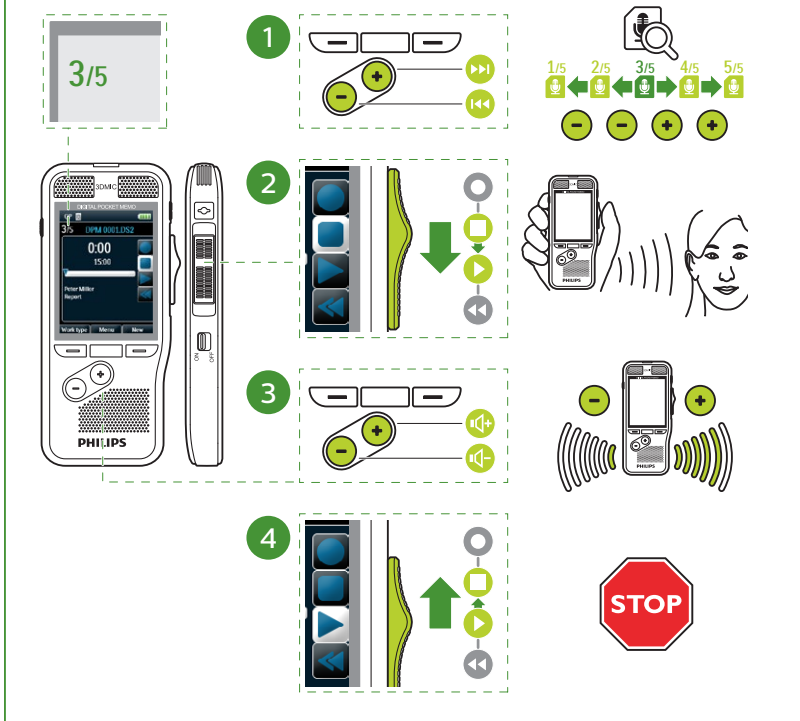
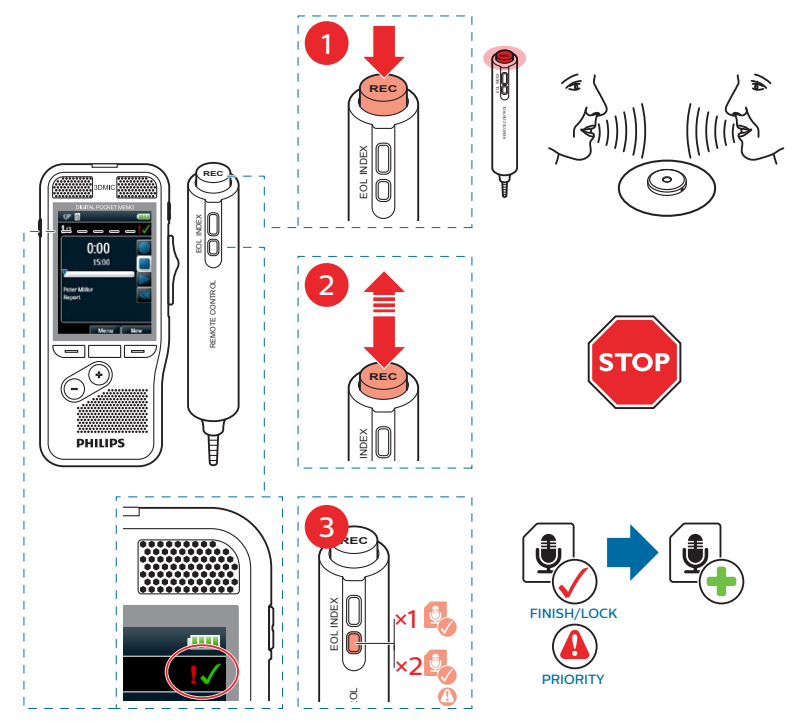
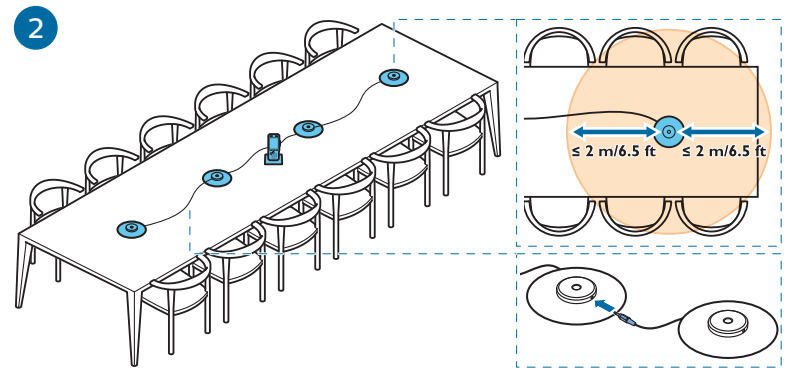
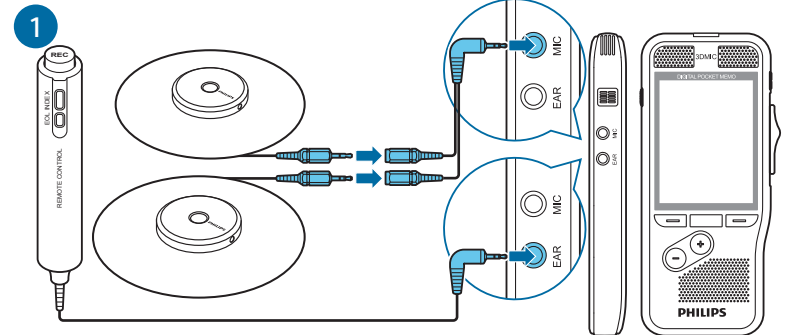



EINZIGARTIG IN BERLIN - IN STUTT GART ZUHAUSE

Danke, dass Sie uns besucht haben !

Dieses Dokument wurde heruntergeladen
bei www.DIKTAT-STUTTART.de

Für die Richtigkeit der im Dokument angegebenen Daten, haftet ausschließlich der
angegebene Hersteller.

Gerne dürfen Sie uns jederzeit wieder besuchen oder bei Fragen auch telefonisch
kontaktieren.

Mit freundlichen Grüßen
Ihr Team von
DIKTAT-STUTTART
ppm-stuttgart • Diktiersysteme
Friedrichstraße 18 – 22, 70736 Fellbach

Tel.: 0711 / 34 16 93- 60
Fax: 0711 / 34 16 93- 66
e-mail: ppm@ppm-stuttgart.de

Sie haben Fragen ?

Sprechen Sie uns einfach an.
Wir stehen Ihnen jederzeit
gerne zur Verfügung.



Büro Stuttgart

Andreas Ester

GF & Kundenbetreuung
Telefon 0711 - 34 16 93 60



Büro Berlin

Alexander Schnell

Key-Account Manager Diktierlösungen
Telefon 0711 - 34 16 93 63